

# COGNEX

## DataMan<sup>®</sup> 8700 DX Reference Manual



2020 June 24  
Revision: 6.2.0.126

# Legal Notices

The software described in this document is furnished under license, and may be used or copied only in accordance with the terms of such license and with the inclusion of the copyright notice shown on this page. Neither the software, this document, nor any copies thereof may be provided to, or otherwise made available to, anyone other than the licensee. Title to, and ownership of, this software remains with Cognex Corporation or its licensor. Cognex Corporation assumes no responsibility for the use or reliability of its software on equipment that is not supplied by Cognex Corporation. Cognex Corporation makes no warranties, either express or implied, regarding the described software, its merchantability, non-infringement or its fitness for any particular purpose.

The information in this document is subject to change without notice and should not be construed as a commitment by Cognex Corporation. Cognex Corporation is not responsible for any errors that may be present in either this document or the associated software.

Companies, names, and data used in examples herein are fictitious unless otherwise noted. No part of this document may be reproduced or transmitted in any form or by any means, electronic or mechanical, for any purpose, nor transferred to any other media or language without the written permission of Cognex Corporation.

Copyright © 2020. Cognex Corporation. All Rights Reserved.

Portions of the hardware and software provided by Cognex may be covered by one or more U.S. and foreign patents, as well as pending U.S. and foreign patents listed on the Cognex web site at: [cognex.com/patents](http://cognex.com/patents).

---

The following are registered trademarks of Cognex Corporation:

Cognex, 2DMAX, Advantage, AlignPlus, Assemblyplus, Check it with Checker, Checker, Cognex Vision for Industry, Cognex VSOC, CVL, DataMan, DisplayInspect, DVT, EasyBuilder, Hotbars, IDMax, In-Sight, Laser Killer, MVS-8000, OmniView, PatFind, PatFlex, PatInspect, PatMax, PatQuick, SensorView, SmartView, SmartAdvisor, SmartLearn, UltraLight, Vision Solutions, VisionPro, VisionView

The following are trademarks of Cognex Corporation:

The Cognex logo, 1DMax, 3D-Locate, 3DMax, BGAll, CheckPoint, Cognex VSoC, CVC-1000, FFD, iLearn, In-Sight (design insignia with cross-hairs), In-Sight 2000, InspectEdge, Inspection Designer, MVS, NotchMax, OCRMax, PatMax RedLine, ProofRead, SmartSync, ProfilePlus, SmartDisplay, SmartSystem, SMD4, VisiFlex, Xpand

Portions copyright © Microsoft Corporation. All rights reserved.

Portions copyright © MadCap Software, Inc. All rights reserved.

Other product and company trademarks identified herein are the trademarks of their respective owners.

# Table of Contents

<b>Legal Notices</b> .....	<b>2</b>
<b>Table of Contents</b> .....	<b>3</b>
<b>Symbols</b> .....	<b>4</b>
<b>Precautions</b> .....	<b>5</b>
<b>Getting Started</b> .....	<b>6</b>
About DataMan 8700 .....	6
DataMan 8700 Accessories .....	6
Miscellaneous Accessories .....	6
Cables .....	8
Physical Layout of the Reader .....	9
<b>Setting Up Your DataMan 8700</b> .....	<b>10</b>
Install the DataMan SetupTool .....	10
Setting Up the Reader .....	10
DataMan 8700 DX Specifications .....	10
DataMan 8700 Imager Specifications .....	12
LED Wavelengths for DataMan 8700DX Reader .....	12
<b>Connection Options</b> .....	<b>13</b>
Connecting Corded DataMan 8700DX .....	13
Troubleshooting an Ethernet Connection .....	13
Using Your Device Through USB .....	13
Changing Communication in DataMan 8700 Corded Reader .....	14
<b>Reading Codes with the DataMan 8700</b> .....	<b>17</b>
Industrial Protocols .....	17
Trigger Types .....	17
Field of View and Reading Distances .....	18
<b>Cleaning and Maintenance</b> .....	<b>20</b>
Cleaning the Reader Housing .....	20
Cleaning the Reader Lens Cover .....	20
<b>Compliance Information, Warnings and Notices</b> .....	<b>21</b>
Regulations and Conformity .....	21
For European Community Users .....	21
中国大陆 RoHS (Information for China RoHS Compliance) .....	22

# Symbols

The following symbols indicate safety precautions and supplemental information:

---

 **WARNING:** This symbol indicates a hazard that could cause death, serious personal injury or electrical shock.

---

---

 **CAUTION:** This symbol indicates a hazard that could result in property damage.

---

---

 **Note:** This symbol indicates additional information about a subject.

---

---

 **Tip:** This symbol indicates suggestions and shortcuts that might not otherwise be apparent.

---

# Precautions

To reduce the risk of injury or equipment damage, observe the following precautions when you install the Cognex product:

- This product is intended for industrial use in automated manufacturing or similar applications.
- The safety of any system incorporating this product is the responsibility of the assembler of the system.
- This product does not contain user-serviceable parts. Do not make electrical or mechanical modifications to product components. Unauthorized modifications can void your warranty.
- Route cables and wires away from high-current wiring or high-voltage power sources to reduce the risk of damage or malfunction from the following causes: over-voltage, line noise, electrostatic discharge (ESD), power surges, or other irregularities in the power supply.
- Changes or modifications not expressly approved by the party responsible for regulatory compliance could void the user's authority to operate the equipment.
- Ensure that the cable bend radius begins at least six inches from the connector. Cable shielding can be degraded or cables can be damaged or wear out faster if a service loop or bend radius is tighter than 10X the cable diameter.
- This device should be used in accordance with the instructions in this manual.
- All specifications are for reference purposes only and can change without notice.

# Getting Started

## About DataMan 8700



The DataMan 8700 readers offer a rugged, industrial housing and advanced technology for reading 1-D and 2-D codes regardless of size, quality, printing method or surface. DataMan 8700 is available with patented 1DMax+ with Hotbars, class leading 2-D PowerGrid algorithm, robust plastics, easy setup, and communication.





The DataMan 8700 readers use Cognex's three unique styles of lighting technology and 2DMax+ algorithms to read the most challenging Direct Part Mark barcodes. Tri-Lucent Lighting provides flexible lighting control to create polarized, bright field, and diffuse lighting.



The DataMan 8700 readers are available with the following communication options:

- Ethernet, with industrial protocols
- USB
- RS-232

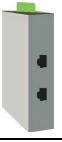
## DataMan 8700 Accessories

### Miscellaneous Accessories







Accessory Name	Accessory Number	Accessory Image
DM8700 slide-in communication conversion kits	DM8700-USB-Kit DM8700-RS-Kit DM8700-ENET-Kit	
Power Supply for reader	DM8700-PWR-00	
POE Adapter	CPS-24V-POE1	
POE Adapter	CPS-24V-POE4	

Accessory Name	Accessory Number	Accessory Image
POE Adapter	CPS-AC-POE1A-xx <sup>1</sup>	
Wall Mount Bracket	DMA-WALL-8700	
Presentation Stand, can be used with wall mount bracket (DMA-WALL-8700)	DM-STAND-00	

---

<sup>1</sup> xx can be US, EN, UK, or JP.

## Cables

Accessory Name	Accessory Number	Accessory Image
RS-232 coiled cable for Reader with Dsub-9 connector, power over pin 9, 2.5 m	DMC-HH-RS232P-02C	
RS-232 coiled cable for Reader with Dsub9 connector, 2.5 m	DMC-HH-RS232-02C	
RS-232 coiled cable for Reader with Dsub9 connector, 4 m	DMC-HH-RS232-05C	
RS-232 Firmware update cable, RS-232 to USB converter	DMC-HH-RS232-USB	
USB straight cable with type A connector, 2.5 m	DMC-HH-USBA-02	
USB straight cable with type C connector, 2.5 m	DMC-HH-USBC-02	
USB coiled cable with type A connector, 2.5 m	DMC-HH-USBA-02C	
USB cable with type C connector, coiled, 2.5 m	DMC-HH-USBC-02C	
Ethernet coiled cable with RJ45 connector, 5 m	DMC-HH-ENET-05C <sup>1</sup>	
Ethernet straight cable with RJ45 connector, 2.5 m	DMC-HH-ENET-02	
Ethernet straight cable with RJ45 connector, 5 m	DMC-HH-ENET-05	
Ethernet straight cable with RJ45 connector, 30 m	DMC-HH-ENET-30	
Ethernet coiled cable with M12 Xcoded connector, 5 m	DMC-HH-ENETM12-05C	

<sup>1</sup> Collimated cable length including DM8700-ECABLE-X should not exceed 50 m.

## Physical Layout of the Reader



**DataMan 8700 Reader**

1	LED aimer
2	Trigger (press and hold to read)
3	Cable
4	360° ring light indicator
5	Lanyard hook
6	OLED display
7	Buttons for OLED input and configuration
8	Diffused light
9	Polarized light
10	Direct light

# Setting Up Your DataMan 8700

## Install the DataMan SetupTool

To configure a DataMan 8700 reader, the DataMan Setup Tool software must be installed on a networked PC. The DataMan Setup Tool is available from the DataMan support site: <http://www.cognex.com/support/dataman>.

1. After installing the software, connect the DataMan 8700 to your PC.
2. Launch the DataMan Setup Tool and click **Refresh**.
3. Select your DataMan 8700 Series reader from the list and click **Connect**.

## Setting Up the Reader

To connect to the reader or base station on your computer:

1. Install the DataMan Setup Tool on your computer.

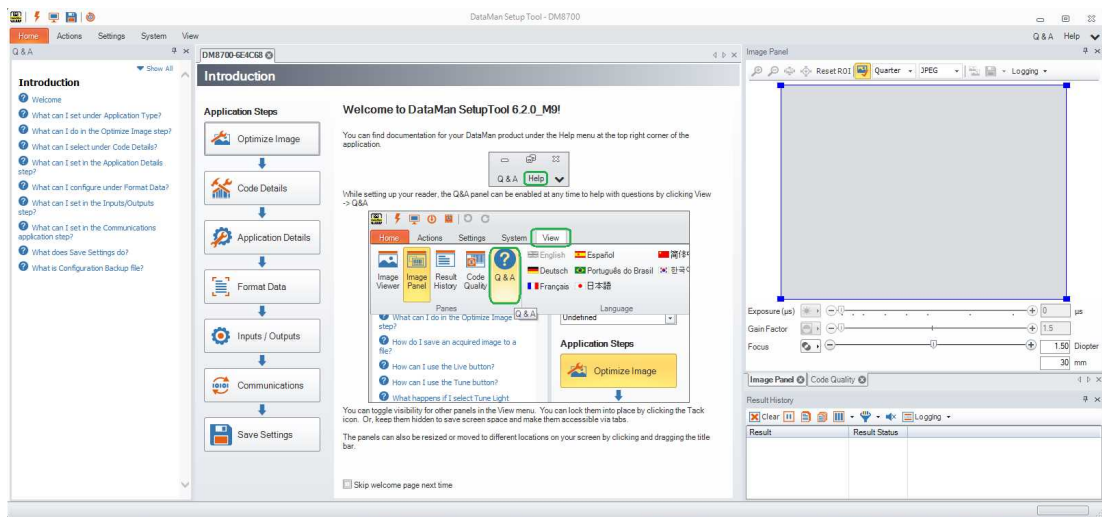

2. Select the connection type: Ethernet, RS-232 Serial, or USB, and connect the cables respectively.



Ethernet



RS-232



USB

3. Turn on your device(s).

## DataMan 8700 DX Specifications

Specification	DataMan 8700 DX Reader
Weight	450 g (15.90 oz) + ~130 g (4.59 oz) cables
Operating Temperature	0 °C — 40 °C (32 °F — 104 °F)

Specification	DataMan 8700 DX Reader
Storage Temperature	-40 °C — 60 °C (-40 °F — 140 °F)
Maximum Humidity	< 95% (non-condensing)
Environmental	ISO 16750-5 Compliant with latest EU RoHS and China RoHS For indoor use only
Symbologies	<b>1-D barcodes:</b> Codabar, Code 39, Code 128, and Code 93, Interleaved 2 of 5, Postal, UPC/JAN, POSTNET, PLANET Code, GS1 IMB <b>2-D barcodes:</b> MaxiCode, Aztec Code, Data Matrix™, QR Code and microQR Code, PDF 417
Power Supply Requirements	Serial/USB: 5.5 V DC, 6.0 W maximum LPS or NEC Class 2 power supply Ethernet: PoE Class 2 power supply
Inrush current peak	In DC and USB mode: 3 A maximum Maximum capacity: 10 µF Maximum inrush: 50 µC
Ethernet	10/100 Base-T FULL/HALF DUPLEX, IEEE 802.3
Protection	ISO 16750-5 IP67 Endures multiple drops from 2.5 m height on concrete

## DataMan 8700 Imager Specifications

Specifications	DataMan 8700 Imager
Image Sensor	1/3 inch CMOS
Image Sensor Properties	3.45 $\mu\text{m}$ square pixels
Image Resolution	1440 x 1080 pixels

## LED Wavelengths for DataMan 8700DX Reader

The following table shows LED types and the related wavelengths:

LED	$\lambda$ [nm]
RED	660

# Connection Options

## Connecting Corded DataMan 8700DX

1. Connect the serial slide-in to your DataMan 8700. See the list of serial slide-ins in [Miscellaneous Accessories on page 6](#).

**Note:** Disconnect the DataMan 8700 from power before inserting or removing the communication modules.

2. Insert the plug, slide the cable lock up to the reader and twist the cable lock in place. See available cables in chapter [Cables on page 8](#)

**Note:** USB and RS232 devices need external power.

## Troubleshooting an Ethernet Connection

If your reader does not appear in the DataMan Setup Tool's list of detected network devices, adjust your network settings.

1. Check your Ethernet connection and click **Refresh** in the DataMan Setup Tool.
2. Scan the **Enable DHCP** code (which you can find in the *DataMan Reader Configuration Codes* document available from the Windows **Start** menu or the Setup Tool **Help** menu). This allows the reader to acquire a suitable IP address from a DHCP server on your subnet.

If the reader still does not appear, you can use the **Add Device** option in the DataMan Setup Tool.

If you know the IP address of the reader, use the **Add Network Device** option under **Repair & Support**. This method allows the DataMan 8700 reader to appear in the list of **Network devices** so that you can connect to it through the DataMan Setup Tool and your Ethernet connection.

## Using Your Device Through USB

You can connect your reader both with a coiled or a straight USB cable to use the device in USB 2.0 mode.

Change the **USB Connection** properties in the **Serial** tab of the **Communication Settings** pane in DataMan Setup Tool, or scan the appropriate code from the *DataMan Configuration Codes* document.

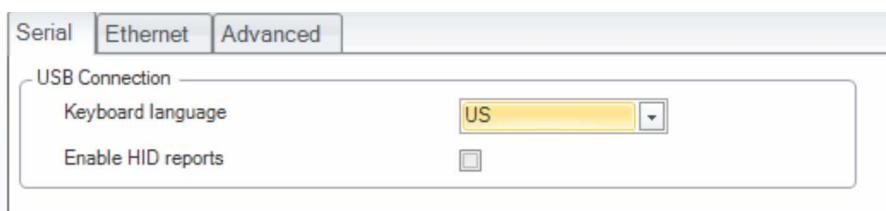

You can also switch the reader to USB mode with a pair of reader configuration codes in the *DataMan Configuration Codes* document. You can enable HID reports by ticking the checkbox in Setup Tool.



1. Open the target window and make sure it is the active window.
2. Start scanning codes with your corded reader.

## Changing Communication in DataMan 8700 Corded Reader

The communication modularity of the DataMan 8700 reader allows using USB, Ethernet and RS-232 slide-in communication type conversion kits. Follow the steps to change the communication conversion kit:

1. Remove the four screws located on the end cap assembly at the base of the reader using a Hex 2.0 mm screwdriver.

**Note:** Save the screws for later use.



2. Pull out the end cap assembly with the internal communication slide-in.

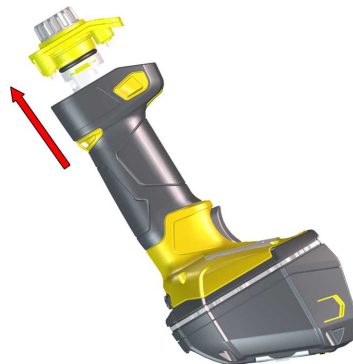

3. Separate the internal slide-in from the end cap assembly.

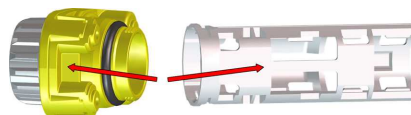

4. Line up the new communication slide-in with the rails on the internal sides of the reader.



5. Insert Internal communication slide-in.



6. Replace the end cap assembly.



7. Insert the screws into the end cap assembly using a Hex 2.0 mm screwdriver.

**i Note:** Use 0.6 Nm (5.31 in-lb) torque on the screws and tighten in the sequence shown in the image.

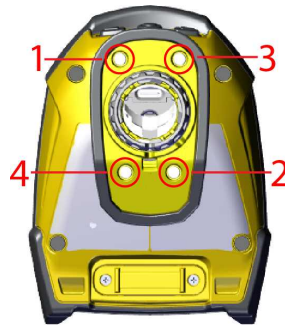

# Reading Codes with the DataMan 8700

## Industrial Protocols

The DataMan 8700 readers support the following industrial protocols:

- EtherNet/IP™
- PROFINET

Select the industrial protocol tools and sample programs when installing the DataMan Setup Tool.

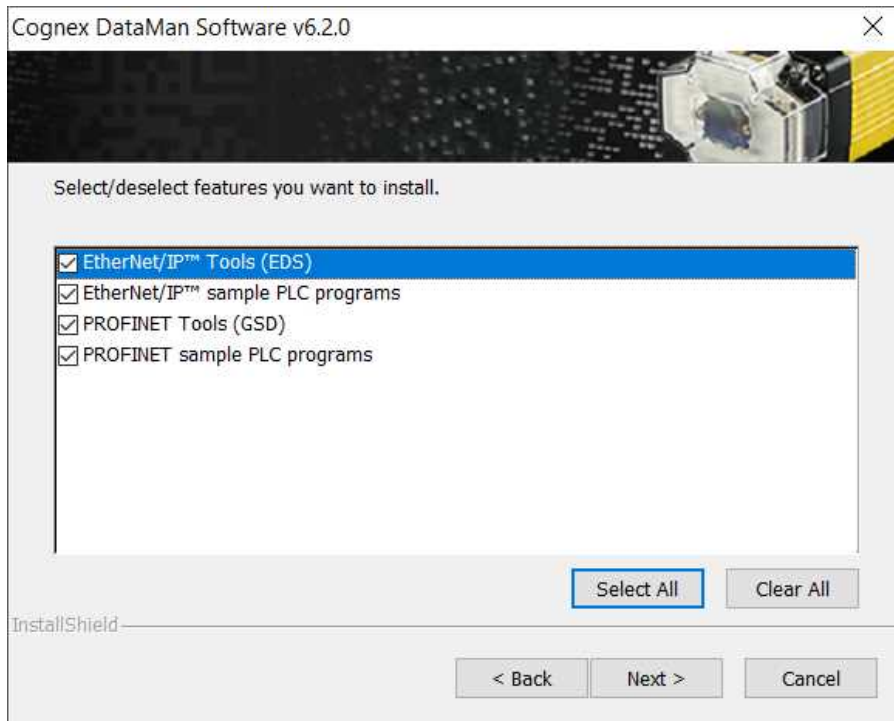

There are three ways to enable or disable Industrial Protocols. Using either method, rebooting the reader is required for the changes to take effect.

- Enable the protocols using the **Industrial Protocols** pane of the DataMan Setup Tool under **Communication Settings**.
- Scan the appropriate **Reader Configuration codes** (see the **Reader Configuration Codes Manual** available through the Windows **Start** menu, the Setup Tool **Help** menu, or the [Cognex Documentation Portal](#)).
- Send the appropriate **DMCC** (see the **DataMan Control Commands Documentation** available through the Windows **Start** menu or the Setup Tool **Help** menu).

For more information on using the industrial protocols, see the **Industrial Protocols Manual** available through the Windows **Start** menu, the Setup Tool **Help** menu, or the [Cognex Documentation Portal](#).

## Trigger Types

The DataMan 8700 trigger mode determines when the reader attempts to read a code. Use the DataMan Setup Tool or the appropriate reader configuration codes to change trigger types.

Supported trigger types:

- Manual (default): Pressing the trigger button on the reader starts image acquisition. The reader continues to acquire images until there is a detectable and decoded image or until the release of the trigger button.
- Presentation: When motion is detected in front of the reader, the reader turns on and scans for a symbol. When no motion is detected, the LED aimer and the lights turn off. The reader relies on an internal timing mechanism to acquire images.

## Field of View and Reading Distances

The following map shows the range of reading distances available for different code sizes and focus positions.

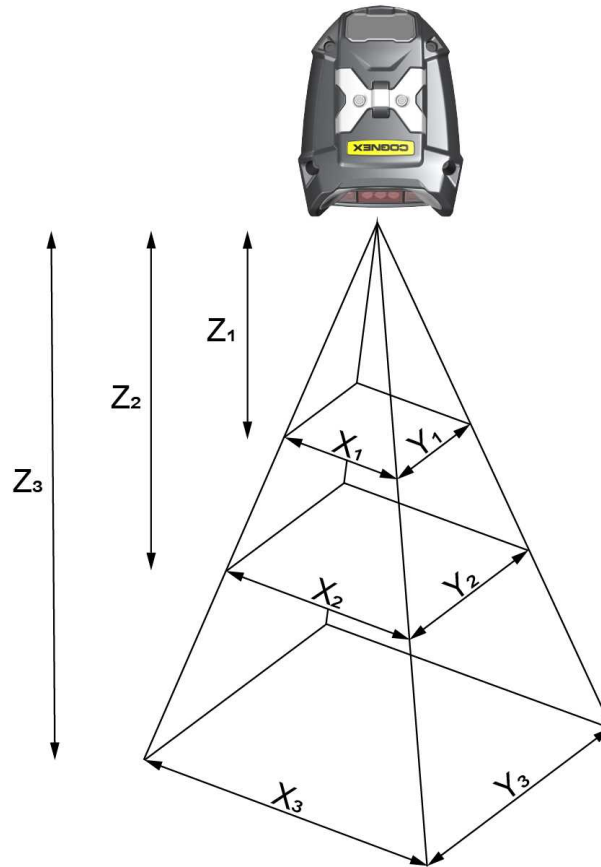

Working Distance	Horizontal Values	Vertical Values
$Z_1 = 40 \text{ mm (1.57 in)}$	$X_1 = 63 \text{ mm (2.5 in)}$	$Y_1 = 47 \text{ mm (1.8 in)}$
$Z_2 = 140 \text{ mm (5.5 in)}$	$X_2 = 126 \text{ mm (5 in)}$	$Y_2 = 95 \text{ mm (3.7 in)}$
$Z_3 = 300 \text{ mm (11.8 in)}$	$X_3 = 288 \text{ mm (11.3 in)}$	$Y_3 = 171 \text{ mm (6.7 in)}$

Distances in mm / 1D min code		Distances in mm / 2D min code	
18-58	3 MIL	10-71	5 MIL
10-175	10 MIL	10-155	10 MIL
0-650	50 MIL	0-650	50 MIL
0-1000	100 MIL	0-1000	100 MIL

**Note:** All values beginning with 0 denote the minimum distance where the Field of View is able to see the entire code.

**i Note:** The calibration distance is 143.0 mm from the nose of the lens, and the calibration tolerance is +/- 5 mm.

# Cleaning and Maintenance

## Cleaning the Reader Housing

To clean the outside of the reader housing, use a small amount of mild detergent cleaner or isopropyl alcohol on a cleaning cloth. Do not pour the cleaner on the reader housing.

---

 **CAUTION:** Do not attempt to clean any DataMan product with harsh or corrosive solvents, including lye, methyl ethyl ketone (MEK) or gasoline.

---

## Cleaning the Reader Lens Cover

To remove dust from the lens cover, use a pressurized air duster. The air must be free of oil, moisture or other contaminants that could remain on the lens cover. To clean the plastic window of the lens cover, use a small amount of isopropyl alcohol on a cleaning cloth. Do not scratch the plastic window. Do not pour the alcohol on the plastic window.

# Compliance Information, Warnings and Notices

## Regulations and Conformity

The corded DataMan 8700 DX has Regulatory Model R00083 and meets or exceeds the requirements of all applicable standards organizations for safe operation. However, as with any electrical equipment, the best way to ensure safe operation is to operate them according to the agency guidelines that follow. Please read these guidelines carefully before using your device.

**Note:** For the most current CE declaration and regulatory conformity information, see the Cognex support site: [cognex.com/support](http://cognex.com/support).

The following specifications apply to the corded DataMan 8700 DX readers:

Regulator	Specification
USA	FCC Part 15B, Class A
Canada	ICES-003
European Community	EN 61010-1 EN 61326-1

Safety and Regulatory	
Manufacturer	Cognex Corporation One Vision Drive Natick, MA 01760 USA
<b>CE</b>	Corded DataMan 8700 DX: Regulatory Model R00083 This is a class A product. In a domestic environment this product may cause radio interference in which case the user may be required to take immediate measures. This equipment complies with the essential requirements of the EU Directive 2014/30/EU. Declarations are available from your local representative.
EU RoHS	Compliant to the most recent applicable directive.
FCC	FCC Part 15, Class A This equipment has been tested and found to comply with the limits for a Class A digital device, pursuant to part 15 of the FCC Rules. These limits are designed to provide reasonable protection against harmful interference when the equipment is operated in a commercial environment. This equipment generates, uses, and can radiate radio frequency energy and, if not installed and used in accordance with the instruction manual, may cause harmful interference to radio communications. Operation of this equipment in a residential area is likely to cause harmful interference in which case the user will be required to correct the interference at his own expense.
Canadian Compliance	This Class A digital apparatus complies with Canadian ICES-003. Cet appareil numérique de la classe A est conforme à la norme NMB-003 du Canada.
TÜV	Corded DataMan 8700: Regulatory Model R00083 NRTL: TÜV SÜD AM SCC/NRTL OSHA Scheme for UL/CAN 61010-1. CB report available upon request. TÜV SÜD AM, IEC/EN 61010-1.

## For European Community Users

Cognex complies with Directive 2012/19/EU OF THE EUROPEAN PARLIAMENT AND OF THE COUNCIL of 4 July 2012 on waste electrical and electronic equipment (WEEE).

This product has required the extraction and use of natural resources for its production. It may contain hazardous substances that could impact health and the environment, if not properly disposed.

In order to avoid the dissemination of those substances in our environment and to diminish the pressure on the natural resources, we encourage you to use the appropriate take-back systems for product disposal. Those systems will reuse or recycle most of the materials of the product you are disposing in a sound way.



The crossed out wheeled bin symbol informs you that the product should not be disposed of along with municipal waste and invites you to use the appropriate separate take-back systems for product disposal.

If you need more information on the collection, reuse, and recycling systems, please contact your local or regional waste administration.

You may also contact your supplier for more information on the environmental performance of this product.

## 中国大陆RoHS (Information for China RoHS Compliance)

根据中国大陆《电子信息产品污染控制管理办法》(也称为中国大陆RoHS), 以下部份列出了本产品中可能包含的有毒有害物质或元素的名称和含量。



Table of toxic and hazardous substances/elements and their content, as required by China's management methods for controlling pollution by electronic information products.

Part Name 部件名称	Hazardous Substances 有害物质					
	Lead (Pb) 铅	Mercury (Hg) 汞	Cadmium (Cd) 镉	Hexavalent Chromium (Cr (VI)) 六价铬	Polybrominated biphenyls (PBB) 多溴联苯	Polybrominated diphenyl ethers (PBDE) 多溴二苯醚
Regulatory Model R00083	X	O	O	O	O	O

This table is prepared in accordance with the provisions of SJ/T 11364.

这个标签是根据SJ/T 11364 的规定准备的。

O: Indicates that said hazardous substance contained in all of the homogeneous materials for this part is below the limit requirement of GB / T26572 - 2011.

表示本部件所有均质材料中含有的有害物质低于GB / T26572 - 2011 的限量要求。

X: Indicates that said hazardous substance contained in at least one of the homogeneous materials used for this part is above the limit requirement of GB / T26572 - 2011.

表示用于本部件的至少一种均质材料中所含的危害物质超过GB / T26572 - 2011 的限制要求。

